



## Switching devices

EsGate, ESD and ESR



**Simple, flexible, safe**

- Easy installation
- Can be configured for an extremely wide range of applications
- High level of safety thanks to tried-and-tested technology

# Switching devices

## Overview

The available switching devices monitor the connected contact mats/safety edges for activation and circuit integrity. The status of the connected sensors can be read off a clear LED/LCD display. The user-friendly devices have easy programming and start up.

## Switching devices selection table

PL and cat. according to EN ISO 13849-1	Design Protection Class	Sensor inputs	Safety outputs	Voltage [V]	Application	Bircher designation	Page
PLe, cat. 3	IP 20	2	2	24	Gate	EsGate 3	4
PLd, cat. 2	IP 20	2	2	24	Gate	EsGate 2	4
PLe, cat. 3	IP 20	2	2 (in series)	230/115/24	Gate/Machine	ESD3	5/6
PLe, cat. 3	IP 30	2	2 (in series)	24	Gate/Machine	ESR31C	7
PLe, cat. 3	IP 30	2	2 (in series)	230/115/24	Gate/Machine	ESR32	7

## Function and conformity

Sensors with a terminating resistor of 8.2 kΩ are connected and monitored for a change of the quiescent current.

Whenever one or multiple sensors are activated, the total resistance falls towards zero Ohm. In the process, the resistance dropping below the defined switching threshold the switching state of the outputs changes and the yellow or orange status LED lights up.

If the sensor circuit is interrupted, the total resistance increases to infinity. In the process, the resistance rising above the defined switching threshold the switching state of the outputs changes and the red status LED lights up.

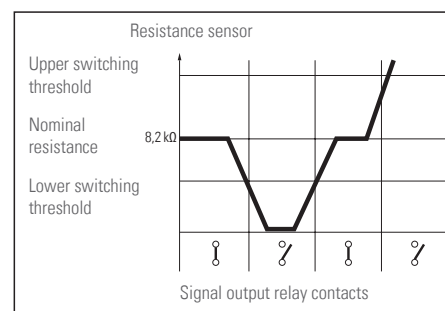

### A) Type-tested safety mat according to MRL 2006/42/EG, EN ISO 13856-1 and EN ISO 13849-1\*

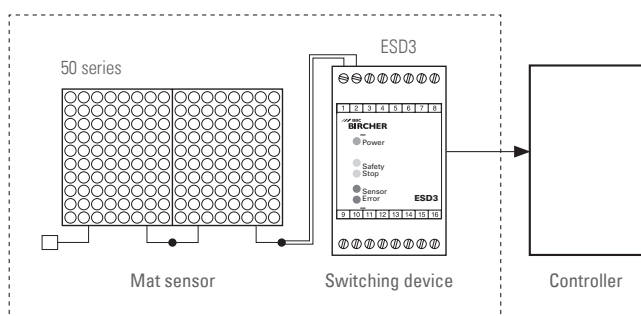

- Safety mat systems connection:
  - Maximum total area of the sensor 5 m<sup>2</sup>
- The sensors are connected in series
- All of the systems are connected at a resistance of 8.2 kΩ

### B) Type-tested safety edge according to MRL 2006/42/EG, EN ISO 13856-2 and EN ISO 13849-1\*

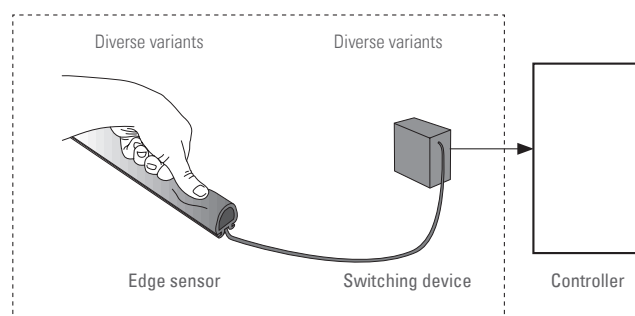

- Safety edge systems connection:
  - Maximum total length of the sensor 25 m
- The sensors are connected in series (ENT-R contact strips max. 4 pieces in series)
- All of the systems are connected at a resistance of 8.2 kΩ

\* The switching devices are type tested as a system in combination with Bircher safety mats or safety edges.

# Switching devices

## Applications in combination with safety mats

### Situation

Machine safety

### Solution

- Protection of hazardous areas in machines with safety mats combined with an ESD3 safety switching device

### Tip

- Combination of multiple safety mats to protect larger areas

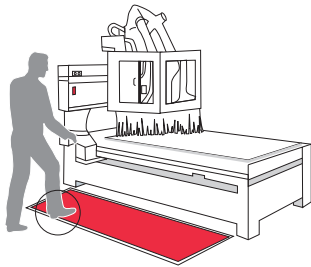

### Situation

Folding door

### Solution

- Protection of the door folding area with a safety mat combined with an ESD3 safety switching device

### Tip

- Combination of a safety edge and an RFGate radio transmission system to protect the closing edge of the door

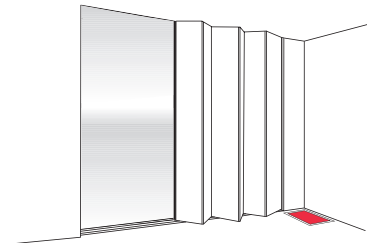

### Situation

Revolving door

### Solution

- EsGate safety switching device in combination with safety edges

### Tip

- Using safety mats to protect revolving doors

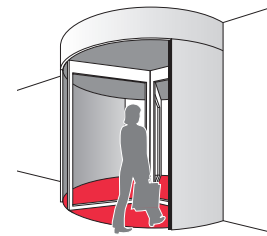

## Applications in combination with safety edges

### Situation

Sliding gate at site entrance

### Solution

- Safety switching edge systems for the four stationary and two mobile safety edges

### Tip

- Combine with RFGate radio transmission system for the mobile safety edge

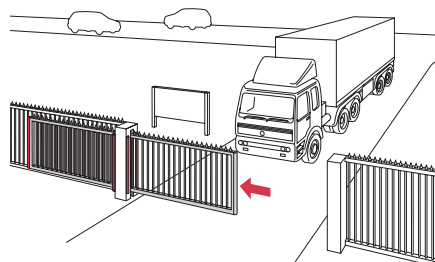

### Situation

Sectional door and gate

### Solution

- Protect the closing edge with a safety edge and a safety switching device

### Tip

- Optimum protection because of mobile safety edges acc. to cat. 2 or cat. 3
- Herkules 2E gate radar as opening sensor. It distinguishes between vehicles and people

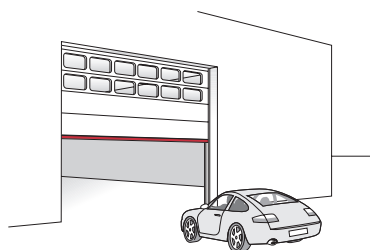

### Situation

Milling or grinding machine with automatic protective door

### Solution

- Protection of moving parts with a safety edge and a safety switching device

### Tip

- Combine with contact mat systems

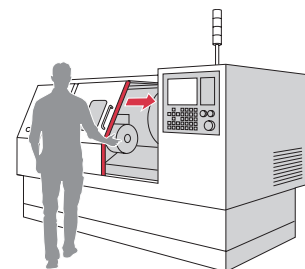

# Switching devices



## EsGate 2 / EsGate 3

- Housing, polyamide red/grey
- EsGate 2 with external test input
- EsGate 3 is self-monitoring
- Performance level d/e, cat. 2/3 acc. to EN ISO 13849-1
- For safety edges acc. to EN ISO 13856-2
- Individually configurable
- Integrated resistance display
- Truly two-channel
- For DIN mounting rail
- Illuminated LCD
- EN 12978

**Block diagram EsGate 2, PLd, cat. 2**

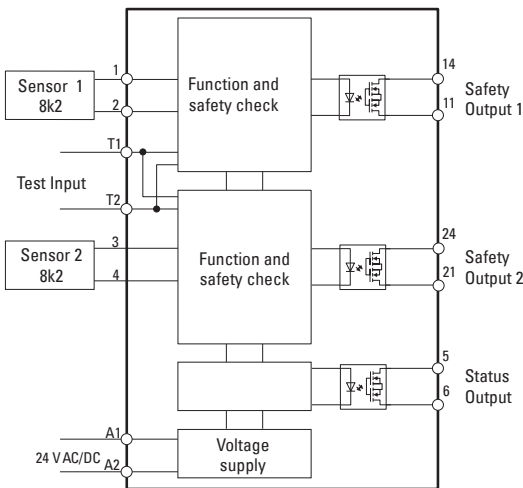

**Block diagram EsGate 3, PLe, cat. 3**

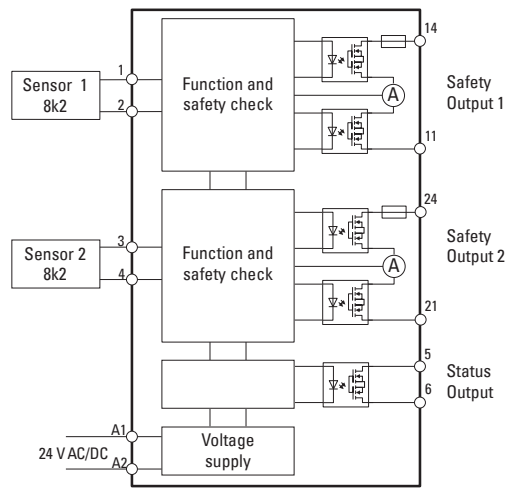

**Dimensional drawing**

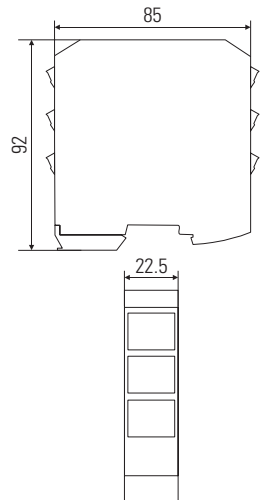

### Specific technical data

<b>Operating voltage</b>	24 V AC $\pm 15\%$ , 50/60 Hz 24 V DC $\pm 15\%$
<b>Power consumption</b>	Max. 3 W
<b>Response time</b>	< 20 ms
<b>EsGate 2 (PL d / Cat 2)</b>	
<b>Safety outputs</b>	Semiconductor relay 24 V AC/DC, max. 50 mA, $R_{DS(on)}$ : approx. 30 $\Omega$ , short-circuit proof
<b>Status relay</b>	Semiconductor relay 24 V AC/DC, max. 50 mA, $R_{DS(on)}$ : approx. 30 $\Omega$ , short-circuit proof
<b>Test input</b>	24 V AC/DC $\pm 15\%$ 2 mA not activated = normal operation, activated = test
<b>EsGate 3 (PL e / Cat 3)</b>	
<b>Safety outputs</b>	Semiconductor relay 24 V DC, 0.5 mA DC up to 50 mA DC, $R_{DS(on)}$ : approx. 60 $\Omega$ , short-circuit proof
<b>Status relay</b>	Semiconductor relay 24 V AC/DC, max. 50 mA, $R_{DS(on)}$ : approx. 30 $\Omega$ , short-circuit proof

# Switching devices



## ESD3

- Housing, ABS grey/black
- Performance level e, cat. 3 acc. to EN ISO 13849-1
- For safety mats acc. to EN ISO 13856-1/  
for safety edges acc. to EN ISO 13856-2
- Auto-, external reset
- Redundant signal evaluation
- Positively driven relays
- Installation on DIN mounting rail

### ESD3 variants

The ESD3 variants are distinguished firstly by their reset function and secondly by the configuration of the status relay contact. This can be implemented off-load both as open and closed. It is not a safety contact, but is exclusively used for transmitting information. It is not monitored for failure and must never be used for safety shutdown in any form whatsoever. Different voltage supply variants are available depending on the type:

Version	Inputs	Safety relay	Reset		Status relay			Voltage variants			
			2	Disconnected	Auto.	External	M	SM	D	230 V AC	115 V AC
03	x	x	x			x			x		x
04	x	x	x		x				x	x	x
05	x	x		x		x					x
06	x	x		x	x						x
08	x	x	x					x			x
09	x	x		x				x			x

### Status relay function

Contacts	Type	De-energised	Sensor not actuated	Sensor actuated (LED yellow)	Fault (LED red)
Safety contacts	all types	0	X	0	0
Fault contact, SM	ESD3 -03, -05	0	X	X	0
Signalling contact, M	ESD3 -04, -06	0	X	0	0
Signalling contact, D	ESD3 -08, -09	X	0	X	X

Key:

0 = contact open

X = contact closed

# Switching devices

## Block diagram and terminal assignment

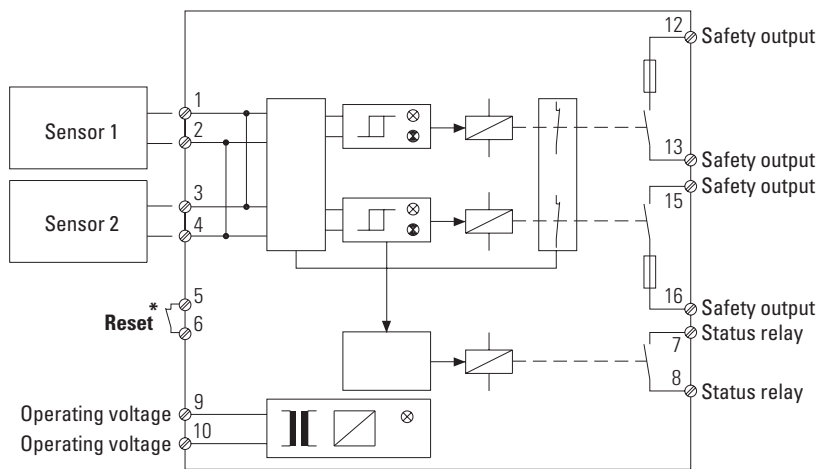

\* Versions with automatic reset have this function integrated in the circuit  
For versions with an external reset, a button must be connected to 5-6 as a break contact.

## Terminals

- Type: 2 x 8-pin, pluggable
- 2 parallel sensor inputs

## Dimensional drawing

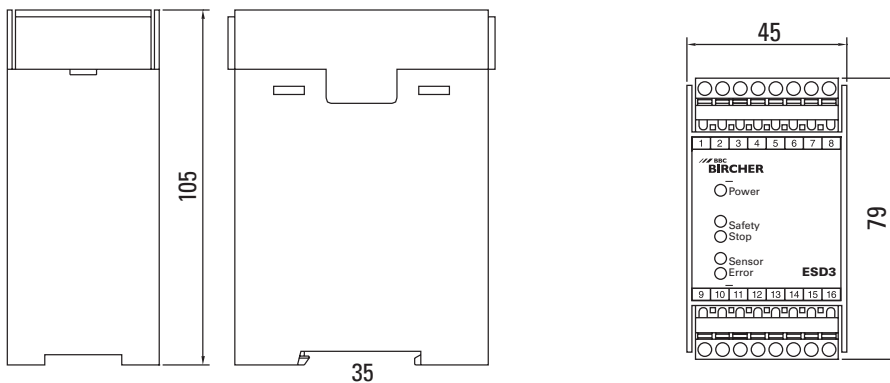

Stick-on labels in the following languages: de, fr, it, es, sv



## Technical data

<b>Operating voltage</b> according to EN 60204-1 (depending on type)	24 V AC $\pm 10\%$ , 50/60 Hz 24 V DC $\pm 10\%$ 115 V AC $\pm 10\%$ , 60 Hz 230 V AC $\pm 10\%$ , 50 Hz
<b>Power consumption</b>	Max. 5 VA
<b>Safety outputs</b>	
<b>Usage category in acc. with EN 60947-4-1</b>	AC-1: 230 V/2 A/460 VA, approx. 280'000 cycles DC-1: 24 V/2 A/48 W, approx. 500'000 cycles
<b>Usage category in acc. with EN 60947-5-1</b>	AC-15: 230 V/2 A/460 VA, approx. 150'000 cycles DC-13: 24 V/2 A/48 W, approx. 80'000 cycles
<b>Internal contact fuse</b>	2 A slow blowing
<b>Mechanical service life</b>	10 million cycles
<b>Status relay</b>	
<b>Switching capacity</b>	24 V DC/1 A, resistive load 30 V AC/1 A, resistive load
<b>Response time</b>	< 50 ms

For further technical data, please see last page

# Switching devices



## ESR31C / ESR32

- Bircher M3 housing, noryl red
- 11-pin connector
- Performance level e, cat. 3 acc. to EN ISO 13849-1
- For safety mats acc. to EN ISO 13856-1/  
for safety edges acc. to EN ISO 13856-2
- Double redundant signal evaluation
- Self-monitoring
- Start-up test
- Automatic or external reset

### Block diagram ESR 31C / ESR 32

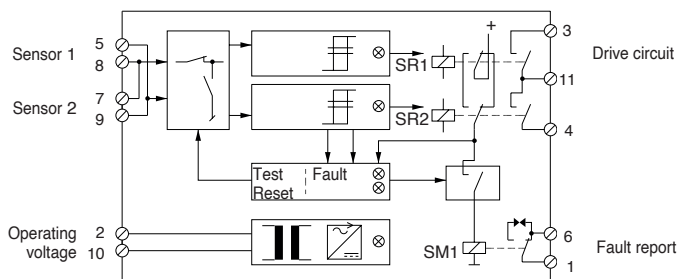

Reset button on ESR31C:  
Green power LED is also the reset button

### Specific technical data

<b>Operating voltage</b>	ESR31C-24VDC: 24 V DC $\pm 15\%$ ESR32-24VDC: 24 V DC $\pm 15\%$ ESR32-115VAC: 115 V AC $+10\%$ / $-15\%$ , 60 Hz ESR32-230VAC: 230 V AC $+10\%$ / $-15\%$ , 50 Hz
<b>Power consumption</b>	Max. 5 VA
<b>Signal output relay</b> <b>Usage category in acc. with EN 60947-4-1</b>	AC-1: 230 V/2 A/460 VA, approx. 280'000 cycles DC-1: 24 V/2 A/48 W, approx. 500'000 cycles
<b>Usage category in acc. with EN 60947-5-1</b>	AC-15: 230 V/2 A/460 VA, ca. 150'000 cycles DC-13: 24 V/2 A/48 W, ca. 80'000 cycles
<b>External contact fuse</b>	2 A sluggish
<b>Mechanical service life</b>	10 million cycles
<b>Response time</b>	< 70 ms
<b>Status relay</b>	30 VDC / 1A, resistive load 30 VAC / 1A, resistive load



## Ordering information

Article no.	Description	
<b>210978</b>	ESD3 -03-230VAC	
<b>210979</b>	ESD3 -03-24VACDC	
<b>210984</b>	ESD3 -04-230VAC	
<b>210983</b>	ESD3 -04-115VAC	
<b>210985</b>	ESD3 -04-24VACDC	
<b>210988</b>	ESD3 -05-24VACDC	
<b>210994</b>	ESD3 -06-24VACDC	
<b>210997</b>	ESD3 -08-24VACDC	
<b>211000</b>	ESD3 -09-24VACDC	
<b>263911</b>	EsGate 2 24VACDC	
<b>263913</b>	EsGate 3 24VACDC	
<b>211897</b>	ESR31C -24VDC	
<b>211922</b>	ESR32 -24VDC	
<b>211903</b>	ESR32 -115VAC	
<b>211909</b>	ESR32 -230VAC	
<b>209745</b>	11-pin plug-in base	

## Supplementary products

### ClickLine

Electrical safety edge  
rubber profiles with click-fit foot

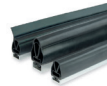

### CoverLine

Electrical safety edge  
rubber profiles for clicking in at the side



### ExpertSystem XRF

Wireless signal transmission system for safety edges  
on roller and sectional gates, folding doors,  
sliding gates at site entrance and telescopic gates



### Safety mats

Electric pushbutton for activating and deactivating  
machines and devices

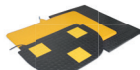

## Technical data

### General mechanical data

**Weight** approx. 250 g (depending on type)

### General electrical data

**Frequency range** 50/60 Hz

**Duty cycle** 100% ED S1

**Displays ESD3, ESR3**

**Operation** Green

**Safety shutdown** Yellow

**Fault (interruption)** Red

**Displays EsGate** 3-color LED / LCD

**Operation** Green

**Safety shutdown** Orange

**Fault (interruption)** Red

**LCD** Additional information

### Ambient conditions

**Protection class switching device**

EsGate, ESD3	IP20
ESR3	IP30

**Operating temperature**

EsGate	-20 °C to +60 °C
ESD3	-20 °C to +55 °C
ESR3	-20 °C to +50 °C

**Storage temperature**

EsGate	-40 °C to +70 °C
ESD3, ESR3	-20 °C to +80 °C

**Air humidity**

EsGate	Max. 95% relative, non-condensing
ESD3, ESR3	Max. 80% relative, non-condensing

### Conformity & Standards

**Conformity** MD 2006/42/EC

**Standards** EN ISO 13849-1

### Note

Technical details and recommendations concerning our products are based on experience and are an aid for the orientation of the user. Details stated in our brochures and data sheets do not guarantee special properties of the products. This does not apply to special product properties confirmed by us in writing or individually. Subject to technical alterations.

### BBC Bircher Smart Access

Wiesengasse 20

8222 Beringen

Switzerland

Phone +41 52 687 11 11

info@bircher.com

bircher.com