



- Cadmium - free contacts
- Height 15.7 mm
- 5000 V / 10mm Reinforced insulation
- For PCB and plug-in sockets
- Accessories: sockets and modules
- AC and DC Coils
- Recyclable packing



RoHS Compliant ✓

### Contacts

Contact arrangement	2C/O, 2NO
Contact material	AgNi, AgNi/Au 5 um, AgSnO <sub>2</sub>
Max. switching voltage	AC 250V / 400V
Min. switching voltage	5V AgNi, 5V AgNi/Au 5 um, 10V AgSnO <sub>2</sub>
Rated load	AC AC1:8A / 250V, AC15:3A / 120V, 1.5A / 240V (B300) DC DC1:8A / 24V, DC13:0.22A / 120V, 0.1A / 250V (R300)
Min. switching current	5mA AgNi, 2mA AgNi/Au 5um, 10mA AgSnO <sub>2</sub>
Max. inrush current	15A AgSnO <sub>2</sub>
Rated current	8A
Max. breaking capacity	AC1 2000VA
Min. breaking capacity	0.3W AgNi, 0.05W AgNi/Au 5 um, 1W AgSnO <sub>2</sub>
Initial resistance	≤ 100 mΩ max, at 0.1A/24VDC
Max. operating frequency	at rated load AC1 600 cycles/hour no load AC1 72,000 cycles/hour

### Coil

Rated voltage	AC/DC 12...240VAC 50/60Hz, 3...110VDC
Must release voltage	AC/DC AC ≥ 0.15Un, DC ≥ 0.1Un
Operating range	See tables 1, 2 and figures 4, 5
Rated power consumption	AC/DC 0.75VA, DC: 0.4...0.48W

### Insulation EN60664-1

Insulation category	C250 / B400	
Insulation rated voltage	400 VAC	
Rated surge voltage	4,000 VAC 1.2/50μs	
Overvoltage category	III IEC 61810-5 (PN-IEC 664-1)	
Insulation pollution degree	3	
Dielectric strength	coil to contact	5,000VAC
	contact to contact	DPDT:1,000 VAC, DPST-NO:2,000VAC (special)
	pole to pole	2,500VAC
Contact - coil distance	clearance & creepage	≥ 10mm
Contact gap		≥ 0.35mm

### General Data

Operating / Release time	typ.	7ms / 3ms
Electrical life	Resistive AC1	> 1 x 10 <sup>5</sup> 8A, 250VAC
	cosφ	See figure 2
	DC L/R=40 ms	> 10 <sup>5</sup> 0.15 A, 220VDC
Mechanical life	ops.	> 3 x 10 <sup>7</sup>

### Environmental

Environmental protection	RTII IEC 61810-7	
Cover protection	IP40 or IP67	
Solder bath temperature / time	max. 270°C / 5s	
Ambient temperature	operating	AC -40 to +70°C, DC -40 to +85°C
	storage	-40 to +85°C
Shock resistance		20g
Vibration resistance	(NO/NC)	10g / 5g 10...150 Hz
Dimensions	L x W x H	29 x 12.7 x 15.7mm
Weight	approx.	14g

### Ordering Code

D M 8 4 - 3 0 1 2 - 2 5 - 1 0 1 2

Series

Coil code:

See table

1 & 2

Contact material

20: AgNi

23: AgNi/Au 5m

30: AgSnO<sub>2</sub>

Contact arrangement

12: 2C/O

21: 2NO

Environmental protection

2: In cover, IP40

3: In cover, IP67 (waterproof)

Mounting & terminations

5: For PCB and sockets

**DC Coil Data**
**Table 1**

Coil code	Rated voltage (VDC)	Coil resistance $\Omega \pm 10\%$ (at 20°C)	Coil operating voltage range (VDC@ 20°C)	
			min.	max.
1003	3	22	2.1	7.6
1005	5	60	3.5	12.7
1006	6	90	4.2	15.3
1009	9	200	6.3	22.9
<b>1012</b>	<b>12</b>	<b>360</b>	<b>8.4</b>	<b>30.6</b>
1018	18	710	12.6	45.9
<b>1024</b>	<b>24</b>	<b>1440</b>	<b>16.8</b>	<b>61.2</b>
1036	36	3140	25.2	91.8
1048	48	5700	33.6	122.4
1060	60	7500	42.0	153.0
1110	110	25200	77.0	280.0

Standard coil rated voltages marked with bold type

**AC Coil Data - 50/60Hz**
**Table 2**

Coil code	Rated voltage (VAC)	Coil resistance $\Omega \pm 10\%$ (at 0°C)	Coil operating voltage range (VAC@ 20°C)	
			min.	max.
5012	12	100	9.6	13.2
<b>5024</b>	<b>24</b>	<b>400</b>	<b>19.2</b>	<b>28.8</b>
5048	48	1550	38.4	57.6
5060	60	2600	48.0	72.0
5110	110	8900	88.0	132.0
5115	115	9600	92.0	138.0
5120	120	10200	96.0	144.0
5220	220	35500	176.0	264.0
<b>5230</b>	<b>230</b>	<b>38500</b>	<b>184.0</b>	<b>276.0</b>
5240	240	42500 $\pm 15\%$	192.0	288.0

Standard coil rated voltages marked with bold type

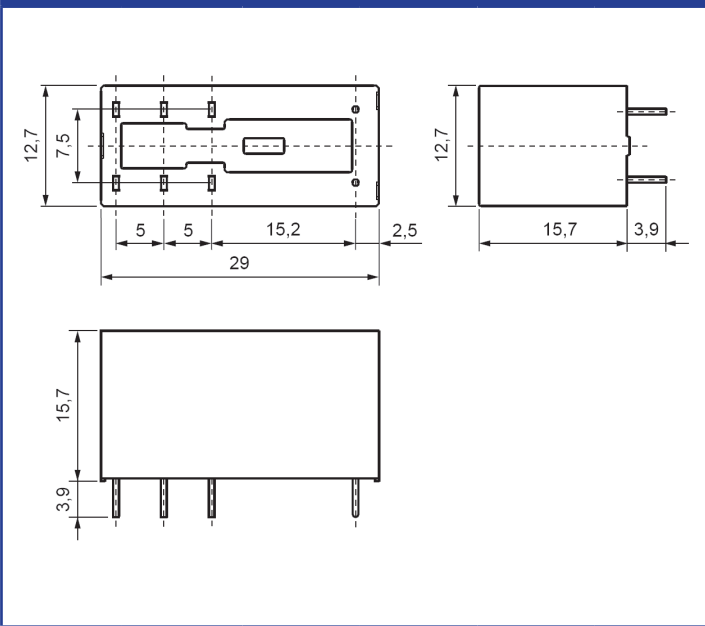
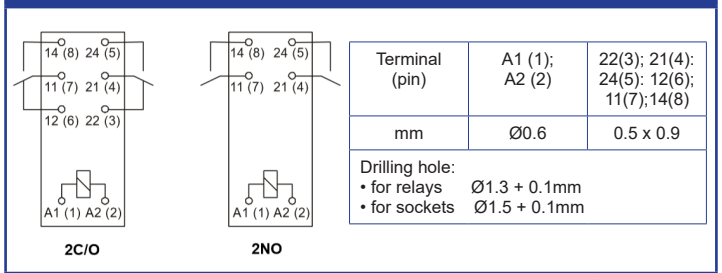
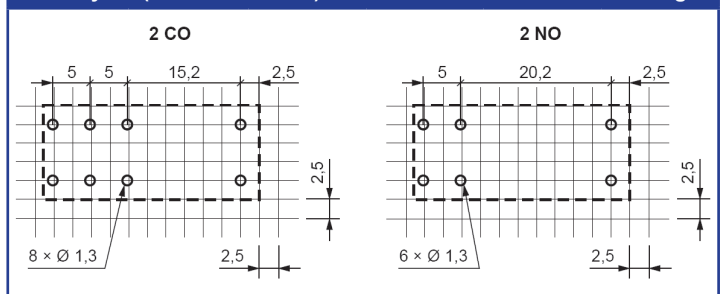
**Dimensions mm**
**Fig. 1**

**Connection Diagrams (pin side view)**
**Fig. 2**

**PCB Layout (solder side view)**
**Fig. 3**

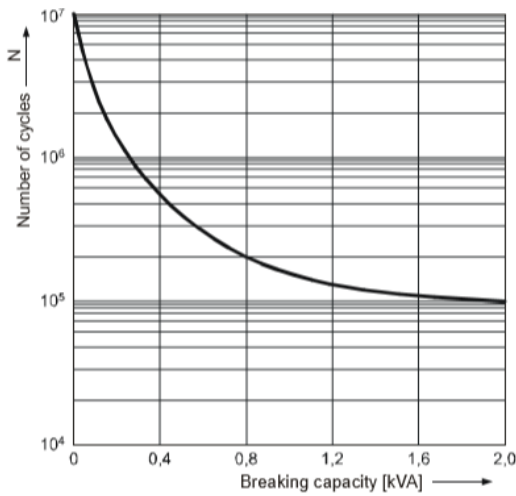
Electrical life at AC resistive load.  
Switching frequency: 600 Cycles per hour

Fig. 4



Electrical life reduction factor  
at AC inductive load

Fig. 5

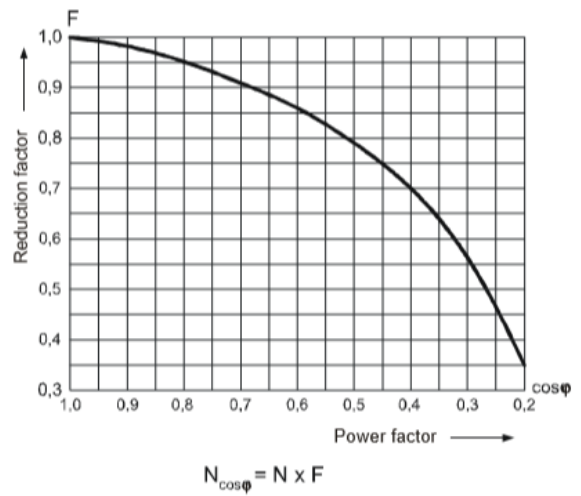

Max. DC resistive load  
breaking capacity

Fig. 6

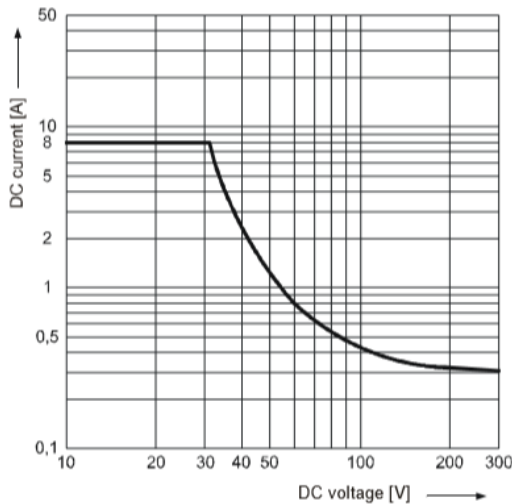

Coil operating range  
DC

Fig. 7

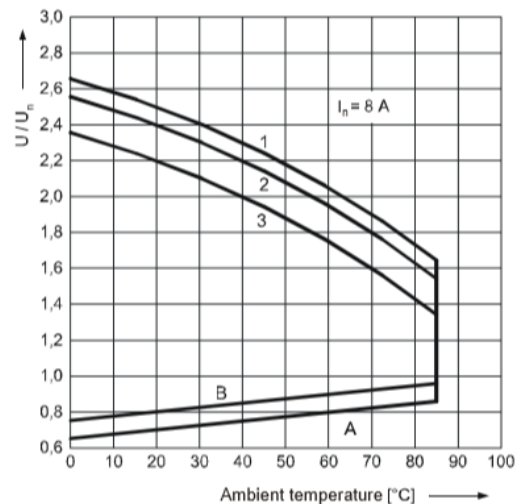

Coil operating range  
AC 50Hz

Fig. 8

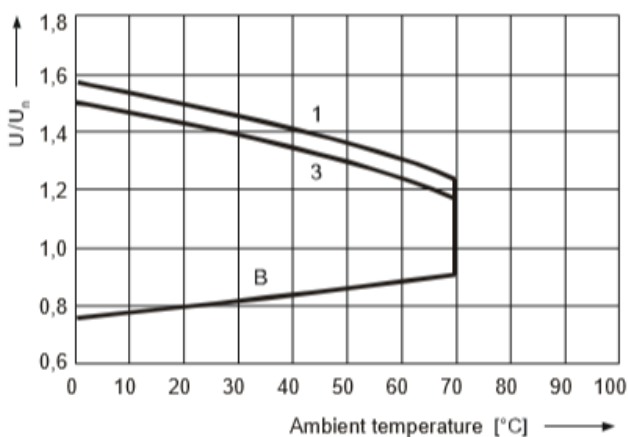

### Relay mounting

Relays DM84 are designed for:

- Direct PCB mounting by soldering
- DIN Rail, or panel mounting, screw terminal plug-in sockets, D14F-2Z-C\* with clip JH-15PS. LED indicator & protecting modules DM\*\*\*-BK are available for D14F-2Z-C\* sockets
- Plug-in sockets for PCB mounting D14F-2Z-A1 or D14F-2Z-A2 with clip JH-15PS

### Description of Fig. 7 and 8

A - relations between make voltage and ambient temperature at no load on contacts. Coil temperature and ambient temperature are equal before coil energizing. Make voltage is not higher than the value read on Y axis (multiplication of rated voltage).

B - relations between make voltage and ambient temperature after initial coil heating up with 1.1 U<sub>n</sub>, at continuous load of I on contacts. Make voltage is not higher than the value read on Y axis (multiplication of rated voltage).

1, 2, 3 - values on Y axis represent allowed overvoltage on coil at certain ambient temperature and contact load:

- 1 - no load
- 2 - 50% of rated load
- 3 - rated load