

# Herkules 2E

Microwave motion sensor for industrial doors

## Original instructions

### 1 Safety instructions

- Read these operating instructions thoroughly before putting the device into operation and keep them for future reference.
- This product is designed to be mounted above an overhead industrial door
- Not a safety component in accordance with the EU Machinery Directive; must not be used for personal protection or EMERGENCY STOP function.
- Do not use this product other than for its specified application.
- Only trained and qualified personnel may install and initialize the device.
- Only authorized factory personnel may perform hardware/software changes or repairs to the product.
- Pay attention to all local relevant electrical safety regulations!
- Failure to follow these safety precautions may cause damage to sensor or objects, serious personal injury, or death.
- It is the responsibility of the equipment installer to carry out a risk assessment and to install the system, in compliance with applicable local, national and international regulations, safety standards, codes and laws as well as the Machinery Directive 2006/42/EC, should this apply.
- Always consider the safety functions of your applications as a whole, never just in relation to one individual section of the system.
- The installer is responsible for testing the system to ensure it meets all applicable safety standards.
- During the operation of electrical components – e. g. in the case of a short circuit hot and ionised gases can be emitted; protection covers must not be removed!
- The sensor should only be operated from a safety extra low voltage (SELV) system with safe electrical separation according to EN 61558. The wiring must be protected against mechanical damage.
- Avoid touching any electronic and optical components.
- The door drive and the transom must be properly earthed.
- **After accessing the inside of the device, ensure the cover/protection seal is closed tightly to achieve designated protection rating.**



### 2 Introduction

#### 2.1 Box Contents & Tools Required

The box contains the following items:

- A** Herkules 2E sensor with pre-wired 10 m 6-wire cable
- B** Self-adhesive mounting template
- C** Instruction manual

#### Tools recommended for installation:

- Ladder
- Tape measure
- Level
- Drill with 5 mm drill bit
- Electric screwdriver with bit to match mounting screws
- AWG 4 (5 mm dia) wire stripper for cable sleeve
- AWG 26 (0.20 mm<sup>2</sup>) wire stripper for single wires

#### Other items recommended for installation:

- Mounting screws (x2) sized for 5 mm hole
- RegloBeam 2 remote control

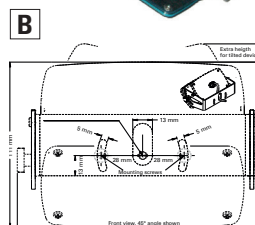

#### 2.2 Parts of the Sensor

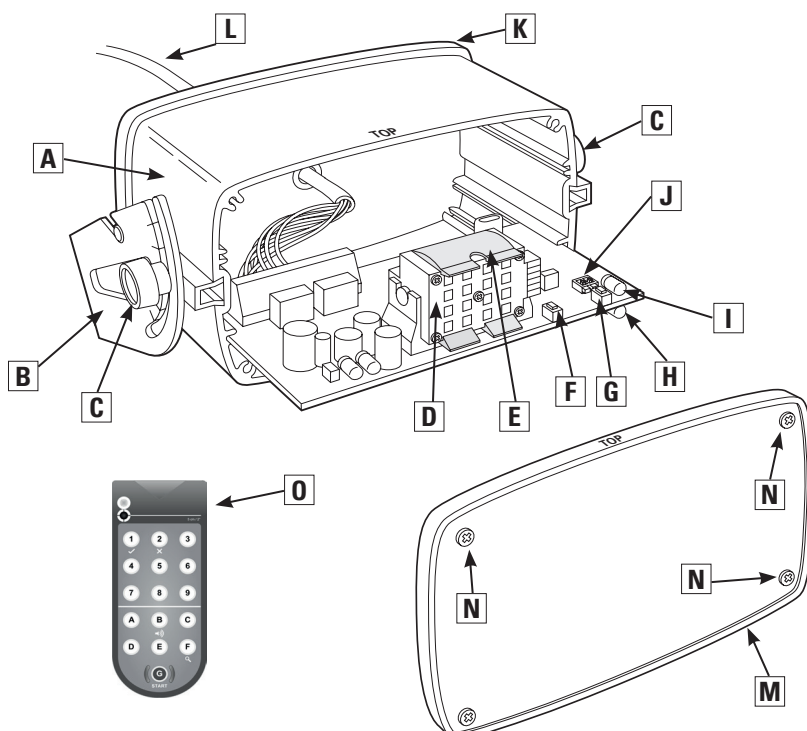

- A** Housing (aluminum)
- B** Mounting bracket
- C** Inclination angle handscrews (x2)
- D** Microwave planar module
- E** Clip for wide detection pattern  
(Use setting for wide field pattern - sec. 6.3)
- F** Left button **L** to set function
- G** Right button **R** to set value
- H** Output 1 indicator (green LED)
- I** Output 2 indicator (red LED)
- J** DIP switches (for setting remote control addresses 1-4)
- K** Rear cover
- L** Connection cable
- M** Front cover
- N** Cover screws (x4)
- O** RegloBeam 2 remote control required to access complete set of functions

### 3 Mounting the Sensor

#### 3.1 Special Considerations

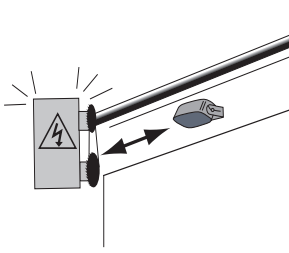

Ensure sensor is firmly mounted on a flat surface. Avoid vibrations.

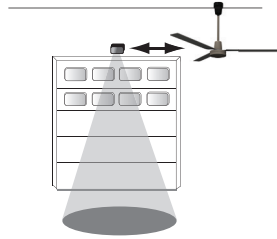

Objects such as fans, plants, flags, etc must not protrude into the detection area.

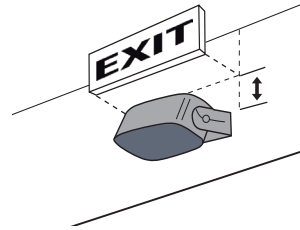

Obstruction can effect performance of sensor. Make sure sensor has an unobstructed view.

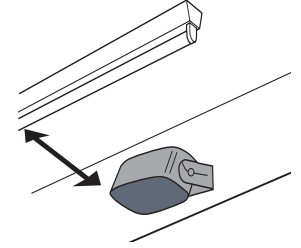

Mount sensor away from fluorescent or HID light sources.

#### 3.2 Mounting Instructions

1. Remove sensor unit from mounting bracket by loosening handscrews.
2. Affix the self-adhesive mounting template to the wall or ceiling and drill holes in specified locations. Remove the template once the holes have been drilled.
3. Route the cable through the opening in the mounting bracket and ensure cable length is sufficient to accommodate desired inclination angle.
4. Secure the mounting bracket tightly to the wall or ceiling using screws.
5. Attach sensor to mounting bracket by aligning the pins and screws on the sensor with the slots on the mounting bracket. Ensure both sides are seated properly. Tighten handscrews to secure.
6. Connect cable to door operator (refer to door operator manual for wiring diagram).

#### Attaching the sensor to the bracket

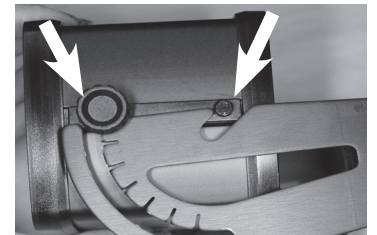

#### Ideal mounting location

Center over door

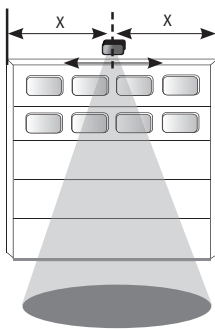

#### Self-adhesive mounting template

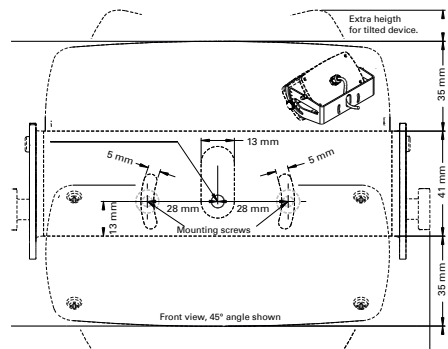

#### Optional ceiling mounting

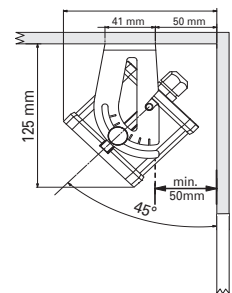

#### 3.3 Inclination Angle

After mounting, adjust the inclination angle to the desired detection pattern. Adjust the inclination angle by loosening the handscrews on the sides of the sensor and adjusting as shown below. Range is 0 - 90°, in 15° increments as marked on the mounting bracket. 30 - 45° is typical for most applications.

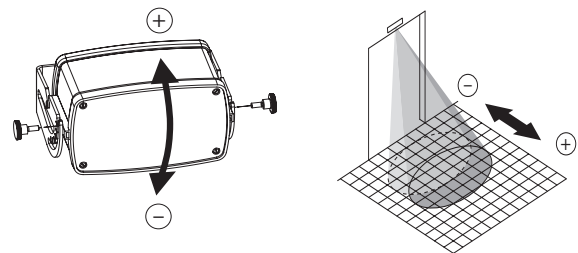

#### 3.4 Tilt Angle

It may be necessary to tilt the sensor for certain applications (not recommended unless warranted by special circumstances). To do so, loosen the handcrews and remove the sensor from the bracket. Once the mounting screws are accessible, loosen them enough to twist the bracket to change the tilt of the sensor.

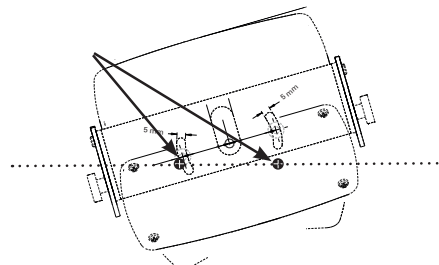
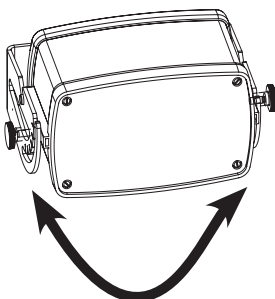

#### Example of application requiring tilt adjustment

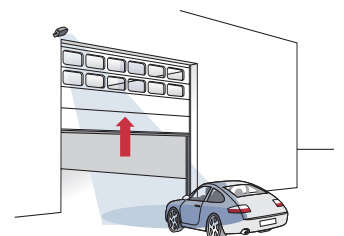

## 4 Electrical Connection

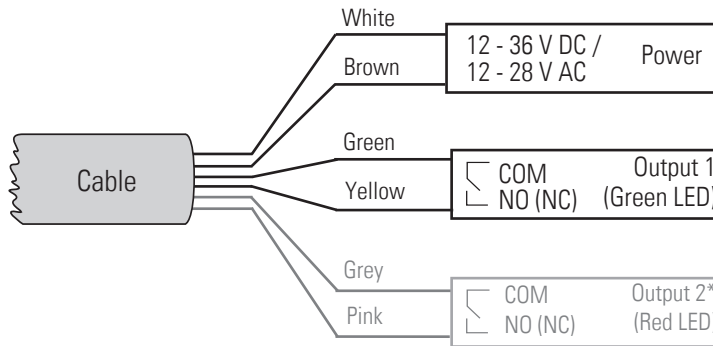

See table on pages 5 & 6 for detailed information on output 1

\*Factory setting = Output 2 off

See table on pages 5 & 6 for detailed information on output 2

### 4.1 Intialisation

Startup sequence after power has been connected to the sensor:

- Both green & red LED's begin to blink slowly
- Green LED will continue to blink quickly

## 5 Introduction to the RegloBeam 2 Remote Control

The RegloBeam 2 remote control allows Herkules 2E to be easily and conveniently programmed from the ground. Data transfer between the RegloBeam 2 and Herkules 2E functions in both directions, i.e. to and from the sensor by an infrared interface. The RegloBeam 2 reads back the adjusted values immediately after programming and displays them on the remote to ensure accurate programming.

**Flashing buttons on the RegloBeam 2 indicate that the data has not been fully transmitted.**

Avoid exposing the infrared interface to direct sunlight or other light sources.

### 5.1 Layout of the RegloBeam 2 Remote Control

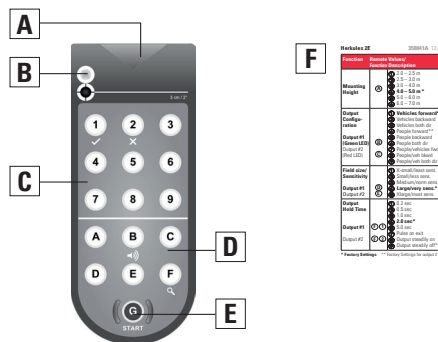

- A** Transmitter/receiver (infrared)
- B** Status indicator LED
- C** Numerical buttons (1 to 9)
- D** Function buttons (A to F)
- E** Start button:
  - a) Powers on (hold 2 sec)
  - b) Establishes connection to the sensor
- F** Remote function quick reference guide (stored in slot on battery compartment cover)  
This guide is included in every Herkules 2E box

### 5.2 Turning on the RegloBeam 2 Remote Control

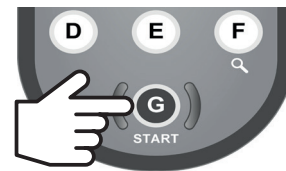

**i** **The RegloBeam 2 must be powered on before use.**

**POWER ON:** Press and hold **G** for 2 seconds  
**POWER OFF\*:** Press and hold **G** for 2 seconds

\*The remote will automatically turn off after 2 minutes if no button is pressed.

### 5.3 Establishing Connection to the Sensor

The RegloBeam 2 functions bidirectionally with the sensor. This means that changes to the settings on the sensor are immediately signalled back by the sensor to the remote control. If an additional parameter is

programmed within 2 minutes of the previous parameter, it is not necessary to press **ⓐ** to re-establish connection to the sensor each time.

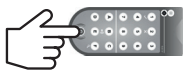

Ensure sensor is in programming mode (section 5.1)

Once **ⓐ** blinks, press **ⓐ** again to establish connection.

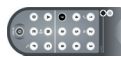

The sensor's address illuminates on the keypad.

EXAMPLE:  
address **⑦**  
(factory setting)

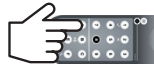

Choose function to be programmed. See chart on following pages for complete list.

Press the desired function (letter) button.

EXAMPLE:  
mounting height **Ⓐ**



The sensor acknowledges its current setting by illuminating it on the keypad.

EXAMPLE:  
**④** = 4 – 5 m  
(factory default)



Now press desired new value.

EXAMPLE:  
Desired height = 3 m  
Choose **③** = 3 – 4 m



The new setting is immediately saved and displayed on the keypad.

Programming of this function is now complete. Repeat for other functions if necessary.

**i** Note: If any buttons are blinking, programming failed. In this case, repeat programming.

## 6 Functions & Settings - Programming by Remote Control

### 6.1 Establishing Connection to the Sensor

The connection between the RegloBeam 2 and Herkules 2E can only be established when the sensor is in programming mode (unlocked). Programming mode is activated when the sensor is switched on. For sa-

fety reasons, this mode is automatically deactivated 30 minutes after the last setting has been made on the sensor. The sensor can be locked at any time by pressing **Ⓕ** **ⓐ** followed by **ⓐ**.

Programming mode can be activated in three different ways:

#### A) Restart the sensor (temporarily disconnect the supply voltage)



#### B) Briefly press one of the buttons inside the sensor unit, **L** or **R**

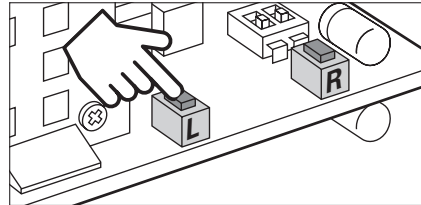

To access programming buttons, open the front cover of the sensor by removing 4 screws.

Replace cover and close securely once button has been pressed.

#### C) Enter access code with remote control



Press **ⓐ** to establish connection to the sensor. The sensor address will illuminate.

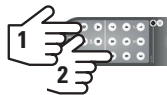

Press **ⓐ** followed by **ⓐ** and enter the 4-digit preset **access code**, followed by **ⓐ**.











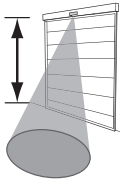







































































































































EXAMPLE:  
**ⓐ** **ⓐ** **①** **②** **③** **④** **ⓐ**

Sensor is now in programming mode.







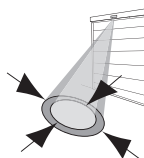
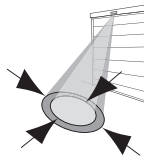



If parameters cannot be changed (buttons blink), repeat sequence.

If connection is still not established, **use option A or B above** (no access code was previously stored.)

## 6.2 Programming Sensor Functions by Remote Control

Sensor Function	RegloBeam 2 Function	Description Factory Settings in <b>bold</b> with *																											
<b>Mounting Height</b> 	<b>A</b>	<table border="1"> <thead> <tr> <th>Height</th> <th>Value</th> </tr> </thead> <tbody> <tr> <td><b>2.0 – 2.5 m</b></td> <td>①</td> </tr> <tr> <td>2.5 – 3.0 m</td> <td>②</td> </tr> <tr> <td>3.0 – 4.0 m</td> <td>③</td> </tr> <tr> <td><b>4.0 – 5.0 m</b></td> <td>④ *</td> </tr> <tr> <td>5.0 – 6.0 m</td> <td>⑤</td> </tr> <tr> <td>5.0 – 7.0 m</td> <td>⑥</td> </tr> </tbody> </table> <p> <b>i</b> <b>Ensure proper mounting height is programmed for optimum sensor performance</b>  <b>i</b> For <b>people/vehicle separation</b> use mounting height <b>3 m</b> and up  <b>i</b> For wide field use mounting height under 4 m                      After mounting height is set, most typical applications require no further programming.                 </p>	Height	Value	<b>2.0 – 2.5 m</b>	①	2.5 – 3.0 m	②	3.0 – 4.0 m	③	<b>4.0 – 5.0 m</b>	④ *	5.0 – 6.0 m	⑤	5.0 – 7.0 m	⑥													
Height	Value																												
<b>2.0 – 2.5 m</b>	①																												
2.5 – 3.0 m	②																												
3.0 – 4.0 m	③																												
<b>4.0 – 5.0 m</b>	④ *																												
5.0 – 6.0 m	⑤																												
5.0 – 7.0 m	⑥																												
<b>Output #1 Configuration</b> Green LED Yellow & green wires 	<b>B</b>	<table border="1"> <tbody> <tr> <td>① *</td> <td> </td> <td><b>Vehicles forward</b></td> </tr> <tr> <td>②</td> <td> </td> <td>Vehicles backward</td> </tr> <tr> <td>③</td> <td>  </td> <td>Vehicles both directions</td> </tr> <tr> <td>④</td> <td> </td> <td>People forward</td> </tr> <tr> <td>⑤</td> <td> </td> <td>People backward</td> </tr> <tr> <td>⑥</td> <td>  </td> <td>People both directions</td> </tr> <tr> <td>⑦</td> <td>  </td> <td>People &amp; vehicles forward</td> </tr> <tr> <td>⑧</td> <td>  </td> <td>People &amp; vehicles backward</td> </tr> <tr> <td>⑨</td> <td>   </td> <td>People &amp; vehicles both directions</td> </tr> </tbody> </table>	① *	 	<b>Vehicles forward</b>	②	 	Vehicles backward	③	  	Vehicles both directions	④	 	People forward	⑤	 	People backward	⑥	  	People both directions	⑦	  	People & vehicles forward	⑧	  	People & vehicles backward	⑨	   	People & vehicles both directions
① *	 	<b>Vehicles forward</b>																											
②	 	Vehicles backward																											
③	  	Vehicles both directions																											
④	 	People forward																											
⑤	 	People backward																											
⑥	  	People both directions																											
⑦	  	People & vehicles forward																											
⑧	  	People & vehicles backward																											
⑨	   	People & vehicles both directions																											
Output #2 Configuration Red LED Pink & grey wires To activate this output, press <b>F</b> ② followed by ① .. ⑦ 	<b>C</b>	<table border="1"> <tbody> <tr> <td>①</td> <td> </td> <td>Vehicles forward</td> </tr> <tr> <td>②</td> <td> </td> <td>Vehicles backward</td> </tr> <tr> <td>③</td> <td>  </td> <td>Vehicles both directions</td> </tr> <tr> <td>④ *</td> <td> </td> <td><b>People forward</b></td> </tr> <tr> <td>⑤</td> <td> </td> <td>People backward</td> </tr> <tr> <td>⑥</td> <td>  </td> <td>People both directions</td> </tr> <tr> <td>⑦</td> <td>  </td> <td>People &amp; vehicles forward</td> </tr> <tr> <td>⑧</td> <td>  </td> <td>People &amp; vehicles backward</td> </tr> <tr> <td>⑨</td> <td>   </td> <td>People &amp; vehicles both directions</td> </tr> </tbody> </table>	①	 	Vehicles forward	②	 	Vehicles backward	③	  	Vehicles both directions	④ *	 	<b>People forward</b>	⑤	 	People backward	⑥	  	People both directions	⑦	  	People & vehicles forward	⑧	  	People & vehicles backward	⑨	   	People & vehicles both directions
①	 	Vehicles forward																											
②	 	Vehicles backward																											
③	  	Vehicles both directions																											
④ *	 	<b>People forward</b>																											
⑤	 	People backward																											
⑥	  	People both directions																											
⑦	  	People & vehicles forward																											
⑧	  	People & vehicles backward																											
⑨	   	People & vehicles both directions																											
<b>Output #1 Field size/sensitivity</b> 	<b>D</b>	<table border="1"> <tbody> <tr> <td>①</td> <td>X-Small field/least sensitive</td> </tr> <tr> <td>②</td> <td>Small field/less sensitive</td> </tr> <tr> <td>③</td> <td>Medium field/normal sensitivity</td> </tr> <tr> <td>④ *</td> <td><b>Large field/very sensitive</b></td> </tr> <tr> <td>⑤</td> <td>X-Large field/most sensitive</td> </tr> </tbody> </table>	①	X-Small field/least sensitive	②	Small field/less sensitive	③	Medium field/normal sensitivity	④ *	<b>Large field/very sensitive</b>	⑤	X-Large field/most sensitive																	
①	X-Small field/least sensitive																												
②	Small field/less sensitive																												
③	Medium field/normal sensitivity																												
④ *	<b>Large field/very sensitive</b>																												
⑤	X-Large field/most sensitive																												
Output #2 Field size/sensitivity 	<b>E</b>	<table border="1"> <tbody> <tr> <td>①</td> <td>X-Small field/least sensitive</td> </tr> <tr> <td>②</td> <td>Small field/less sensitive</td> </tr> <tr> <td>③</td> <td>Medium field/normal sensitivity</td> </tr> <tr> <td>④ *</td> <td><b>Large field/very sensitive</b></td> </tr> <tr> <td>⑤</td> <td>X-Large field/most sensitive</td> </tr> </tbody> </table>	①	X-Small field/least sensitive	②	Small field/less sensitive	③	Medium field/normal sensitivity	④ *	<b>Large field/very sensitive</b>	⑤	X-Large field/most sensitive																	
①	X-Small field/least sensitive																												
②	Small field/less sensitive																												
③	Medium field/normal sensitivity																												
④ *	<b>Large field/very sensitive</b>																												
⑤	X-Large field/most sensitive																												

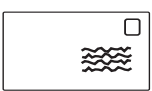
\* Factory settings

Sensor Function		RegloBeam 2 Function	Description Factory Settings in <b>bold</b> with *
Output #1 Hold Time		<b>F</b> ①	① 0.2 sec ② 0.5 sec ③ 1.0 sec ④ * <b>2.0 sec</b> ⑤ 5.0 sec ⑦ Pulse on exit ⑧ Output steadily on (for testing purposes only) ⑨ Output steadily off
Output #2 Hold Time		<b>F</b> ②	① 0.2 sec ② 0.5 sec ③ 1.0 sec ④ 2.0 sec ⑤ 5.0 sec ⑦ Pulse on exit ⑧ Output steadily on (for testing purposes only) ⑨ * <b>Output steadily off</b>
Output #1 Logic		<b>F</b> ③	① * <b>NO</b>  ② NC 
Output #2 Logic		<b>F</b> ④	① * <b>NO</b>  ② NC 
Cross-Traffic Optimization (CTO)		<b>F</b> ⑤	① * <b>Off - Door always activates when any crossing</b> ② Low - Door occasionally activates when crossing traffic is detected ③ Medium - Door rarely activates when crossing traffic is detected ④ High - Door ignores most crossing traffic
Interference Filter		<b>F</b> ⑥	① * <b>Off</b> ② On - Use when electromagnetic sources such as fluorescent bulbs, HID lights, wireless systems, motors/inverters are causing interference
Slow Motion Detection (SMD) (People only)		<b>F</b> ⑦	① * <b>Off</b> ② On - holds door open as long as people are slightly moving in front of the door (LED will blink)
Remote control communication address		<b>F</b> ⑧	⑤ – ⑦ Available addresses that can be set by remote ⑦ * Factory setting ⑨ Reads & sets address (1-4) set by DIP switch on sensor unit Once address is changed, press <b>G</b> to re-establish connection with sensor
Set Access Code (To unlock sensor see page 4)		<b>D</b> ⑨	<b>i</b> <b>Before setting access code, always use delete access code</b> To set access code, enter <b>D</b> ⑨ followed by any 4-digit number from <b>1 1 1 1 - 9 9 9 8</b> ending with <b>D</b> . Access code is now stored. To delete access code, enter <b>D</b> ⑨ <b>9 9 9 9</b> ending with <b>D</b> .
Delete Access Code			
Lock Sensor to Remote Access		<b>F</b> ⑧	⑧ Forces sensor to exit programming mode. Further changes cannot be made until programming mode is entered again (See section 5.1).
Factory Reset		<b>A</b>	⑨ Completes factory reset All settings listed in this table with * will be restored.

\* Factory settings



In cases when no remote control is available, several crucial functions can be programmed by using the buttons on the sensor unit. All remaining functions must be configured by remote control.

1. **Unscrew** all front cover screws and remove the front cover to locate buttons.
2. **Briefly press L and R** simultaneously to enter programming mode
3. Press button **L** to change the **function**. The function increases by 1 for every button press. Once the last function has been reached, the program returns to the first function. The red LED flashes to indicate the number of the activated function.
4. Press button **R** to change the **value**. The value increases by 1 for every button press. Once the last value has been reached, the program returns to the first level.
5. **Briefly press L and R** simultaneously to exit programming mode or wait 25 sec and the sensor will exit automatically.

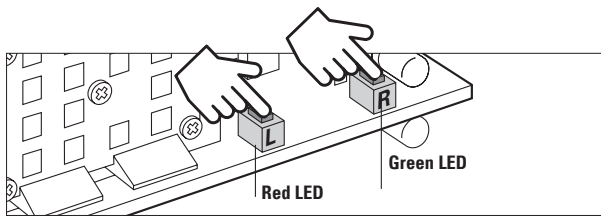

6. Replace the front cover and tighten all 4 screws.

Function	Function # (Button L / Red LED)	Values (Button R / Green LED)
Mounting Height	1	1-6 (see table on pg 5)
Output 1 Configuration	2	1-9 (see table on pg 5)
Output 1 Field Size/ Sensitivity	3	1-5 (see table on pg 5)
Wide Field Setting	4	1-2 (see sec. 7.3)

7.1 Factory Reset

- Press **L** and **R** simultaneously and hold for **8 seconds**.
- Every 2 seconds, one LED illuminates briefly.
- Both LED's illuminate after 8 seconds
- The reset is complete when both buttons are released.

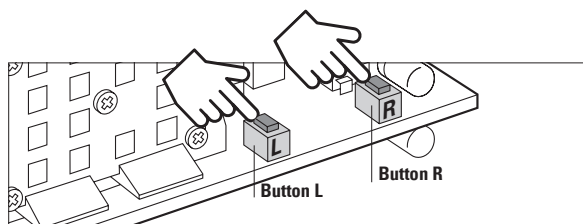

7.2 Programming Addresses 1-4 (by DIP Switch on the Sensor)

Unscrew the 4 front cover screws and remove the front cover of the sensor to locate the DIP switches (refer to section 1.2 for more information). Ensure the cover is closed securely when addressing is complete.

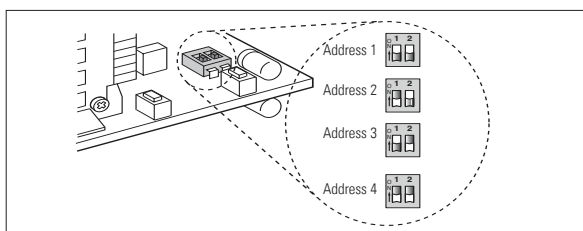

7.3 Wide Field

1. Activate the wide field setting

If wide sensing field is desired, follow programming instructions below and use the clip accessory on the sensor unit.

**i** The sensor will not function correctly if the clip is used without the proper wide field setting or vice versa.

The wide field setting is only available for mounting heights up to 4 m. Sensor will not allow wide field setting to be activated if a higher mounting height is selected.

Normal field without clip\*

Wide field with clip

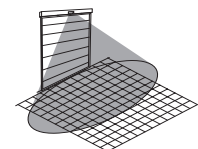
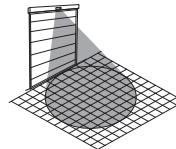

Value	Wide Field Setting
1	Off *
2	on

\* factory setting

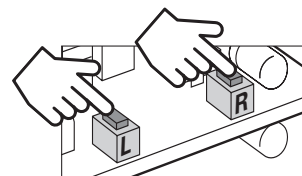

Briefly press **L** and **R** simultaneously to enter programming mode.

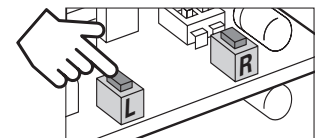

Press **L** 3 times to enter wide field function. The red LED will blink 4 times.

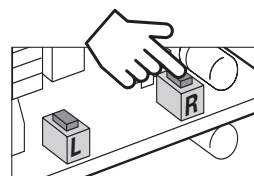

Press **R** once to turn on wide field and twice to turn off (factory setting = off). The green LED will blink the corresponding # of times to verify selection

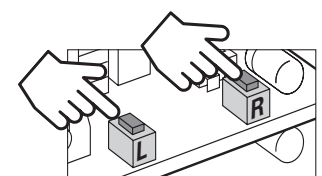

Briefly press **L** and **R** simultaneously to exit programming mode.

Changes are saved immediately.

2. Detection fields Various sensitivities

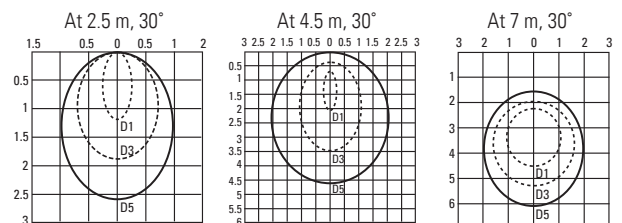

Various sensitivities with clip

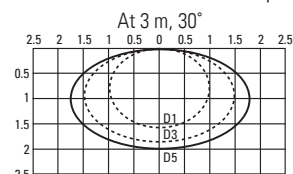

## 8 Troubleshooting

Fault	Remedy
People/vehicle separation does not work as expected	Check mounting height & setting (recommended > 3 m) Check mounting situation & environment (best: sensor centered above door) Check setting/clip for wide field pattern
Late detection of traffic	Increase field size/sensitivity Adjust inclination angle to move the pattern away from the door
Door reverses (sensor reacts to closing door)	Adjust inclination angle to move the pattern away from the door Reduce field size/sensitivity Make sure sensor is tightly fixed and its mounting support does not vibrate
Door opens without motion of a vehicle (or person)	Mount sensor away from EMC interference (e.g. fluorescent tubes, HID lamps, wireless system, motor/inverter, etc.) Point pattern away from EMC interference Activate interference filter
Door does not activate though sensors signals detection (LEDs)	Check wire colors against output selection
Late detection or non-detection of people	Reduce mounting height (recommended < 5 m)
Door stays open	Change output logic

## 9 Technical data

Technology	Doppler radar with planar module
Transmitting frequency	24.05–24.25 GHz
Transmitting power	< 20 dBm
Operating voltage	12–36 V DC 12–28 V AC, 45-65 Hz
Operating current	max 75 mA
Temperature range	–30° bis 60° C
Air humidity	0% to 95% relative, without condensation
Mounting height	2 to 7 m
Relay outputs	Potential-free changeover contacts
Switching voltage	max 48 V AC/DC
Switching current	max 0.5 A AC/DC

Housing	Aluminium black anodized, Cover Polycarbonat
Dimensions	134 x 82 x 75 mm
Weight	820 g incl. cable
Protection class (EN 60529)	IP65
Max. detection speed	25 km/h for vehicles
Cable	Length 10 m, 6 x 0.20 mm <sup>2</sup>

## 10 EU Declaration of Conformity



See attachment

## 11 WEEE



Devices with this symbol must be treated separately during disposal. This must be done in accordance with the laws of the respective countries for environmentally sound disposal, processing and recycling of electrical and electronic equipment.

## 12 FCC approval



This device meets the requirements of Part 15 of the FCC regulations and the RSS-210 standard of Industry Canada.

**Warning:** Changes or modifications made to this device may void the FCC authorisation to operate this device.

## 13 Contact

**BBC Bircher Smart Access**, BBC Bircher AG, Wiesengasse 20, CH-8222 Beringen, [www.bircher.com](http://www.bircher.com)

Made in China / Designed in Switzerland