

# XRF-RD

Dual channel receiver to XRF wireless transmission system

## Original operating instructions

Intended use: Monitoring safety edges and switches on industrial doors and gates

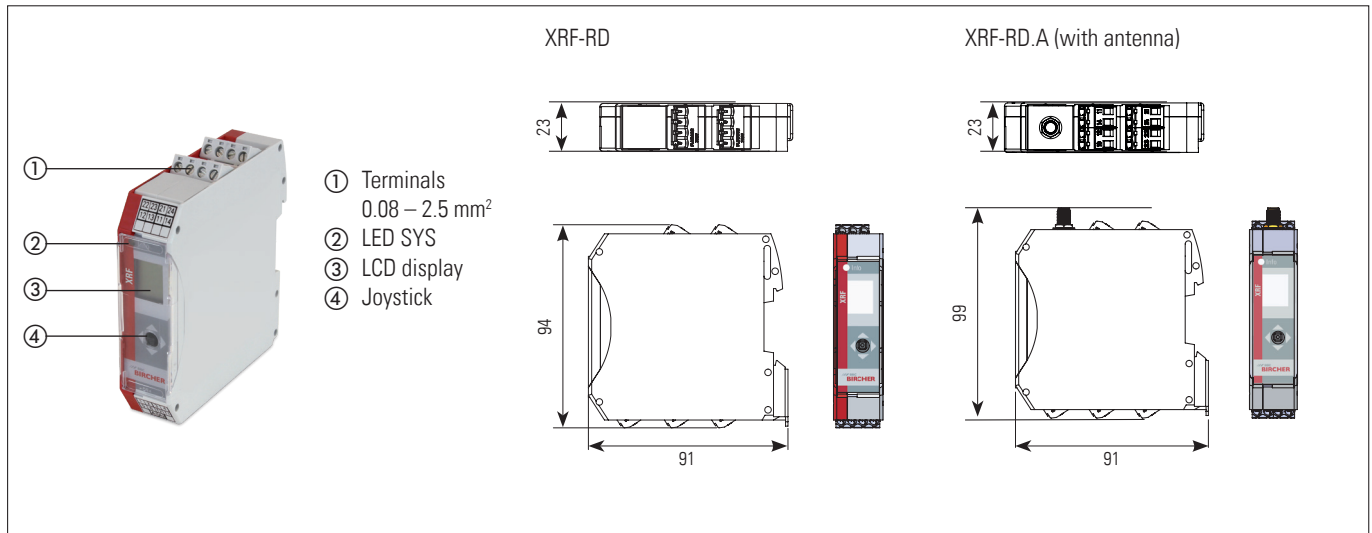

## 1 Safety instructions

- Read these operating instructions thoroughly before putting the device into operation and keep them for future reference.
- Do not use this product other than for its specified application.
- Only trained and qualified personnel may install and initialize the device.
- Only authorized factory personnel may perform hardware/software changes or repairs to the product.
- Failure to follow these safety precautions may cause damage to sensor or objects, serious personal injury, or death.
- It is the responsibility of the equipment manufacturer to carry out a risk assessment and to install the system in compliance with applicable local, national and international regulations, safety standards, codes and laws as well as the Machinery Directive 2006/42/EC, should this apply.
- Always consider the safety functions of your applications as a whole, never just in relation to one individual section of the system.
- The installer is responsible for testing the system to ensure it meets all applicable safety standards.
- Safety devices that are classified as Category 2 according to EN ISO 13849-1 must be tested regularly – at least once per cycle.
- If the safety device is not requested operationally at least once a year, it must be checked manually by the operator at least once a year.
- During the operation of electrical components – e. g. in the case of a short circuit, hot and ionised gases can be emitted; protection covers must not be removed!
- The sensor should only be operated from a safety extra low voltage (SELV) system with safe electrical separation according to EN 61558. The wiring must be protected against mechanical damage.
- Check the voltage data on the label of the switching device.
- Pay attention to all local relevant electrical safety regulations.
- Ensure that the device/installations cannot be switched on.
- Ensure that the power supply is disconnected.
- Protect the device with a housing against contamination or harsh environments.
- Disconnect device from mains in the event of a fault.
- After accessing the inside of the device, ensure the cover/protection seal is closed tightly to achieve the designated protection rating.



## 2 Common applications

Transmitter Tx1 (input 1) corresponds to receiver **output 1**  
Transmitter Tx2 (input 1) corresponds to receiver **output 2**

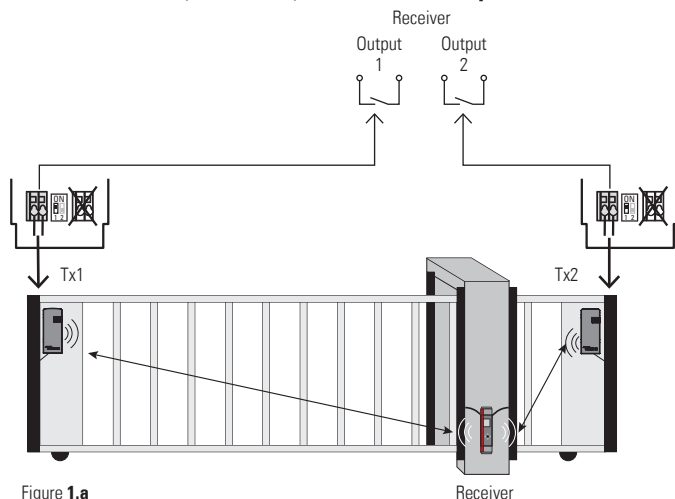

Figure 1.a

Max.14 transmitters in this configuration

Transmitter **input 1** corresponds to receiver **output 1**  
Transmitter **input 2** corresponds to receiver **output 2**

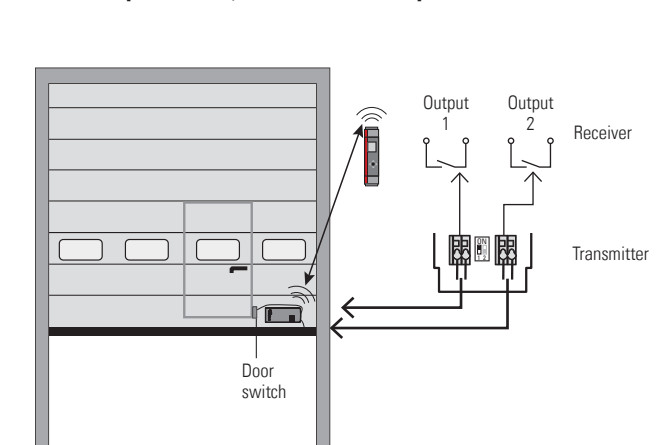

Figure 1.b

Max.7 transmitters in this configuration

### 3 Installation

According to the application, e.g. figure 1.a or 1.b

### 4 Wiring

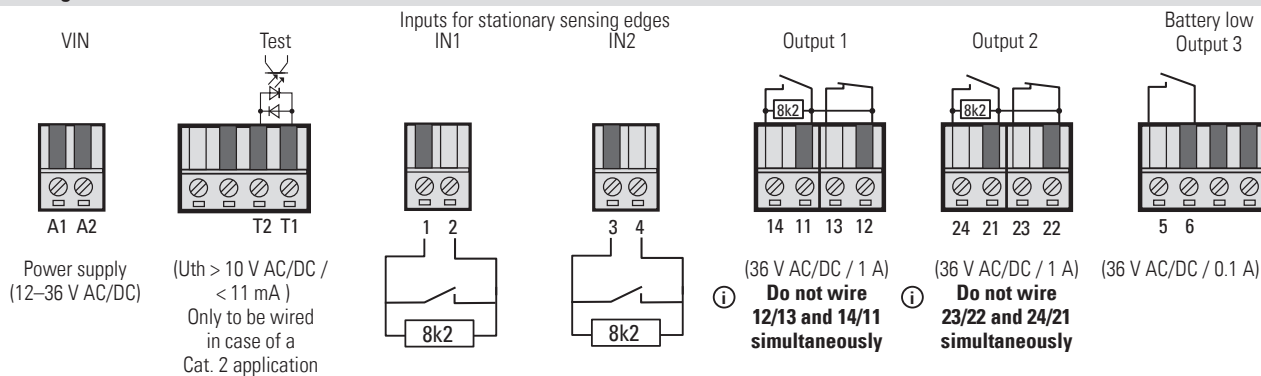

**Note:** When using the NC outputs (13/12, 23/22), in Cat. 3 set-up, the wiring with the control must be permanently installed and protected against external damage according to EN ISO 13849-2 Tab.D.4 or else Cat. 2 applies and a test signal is needed

### 5 Configuration

#### Configure mode

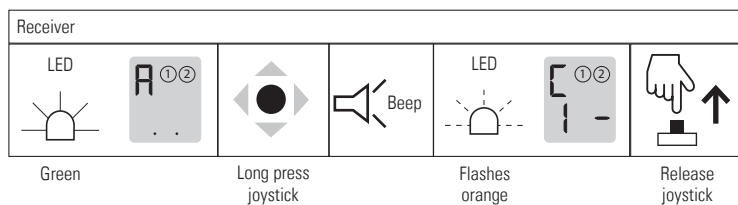

(see also manual of transmitter)

#### 5.1.a Pairing, using the first inputs of different transmitters

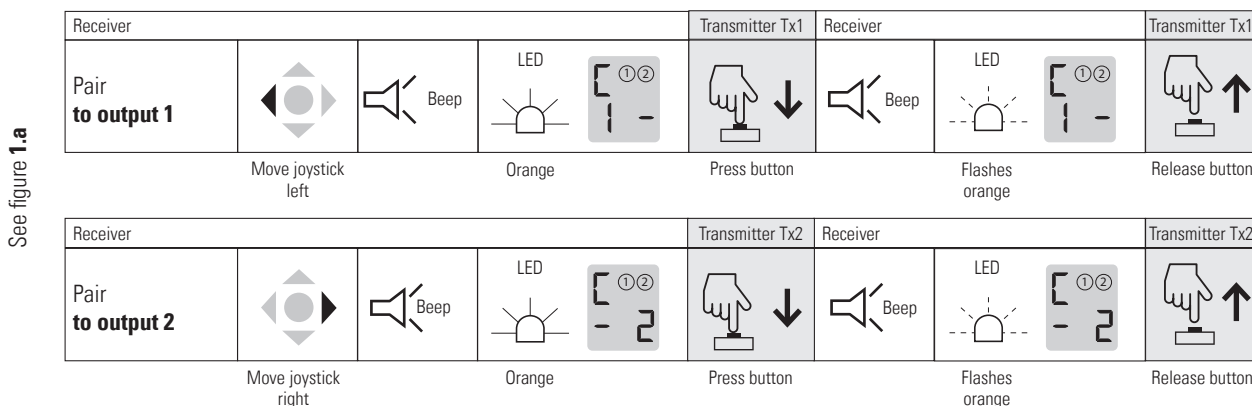

#### 5.1.b Pairing, using both inputs of transmitter

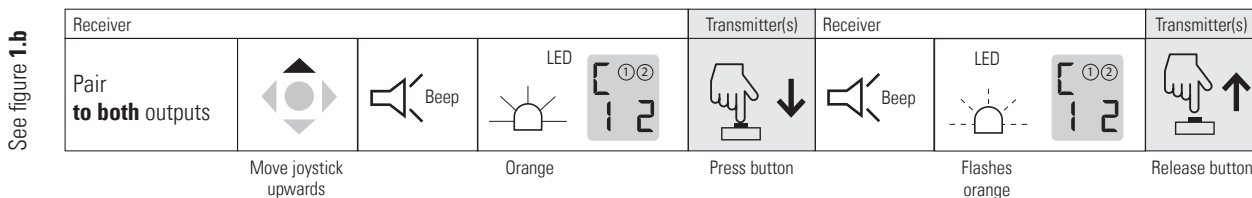

#### 5.2 Bircher signal indicator (BSI) Details see supplementary sheet

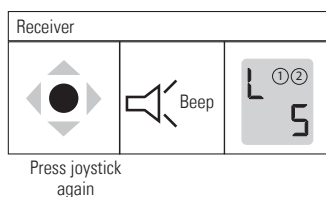

Buzzer + LED flashing green level of Bircher signal indicator

#### 5.3 Configure inputs for stationary sensors

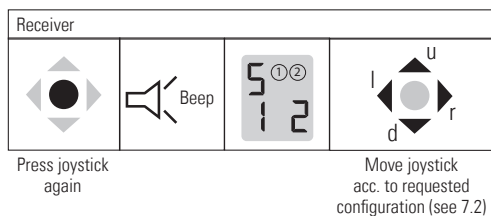

## 5.4 Configure test input

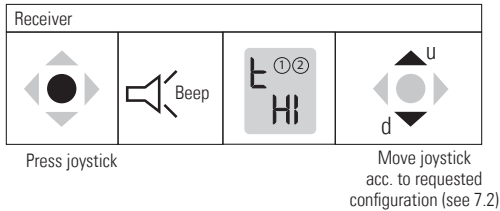

### Leave configuration mode (always possible)

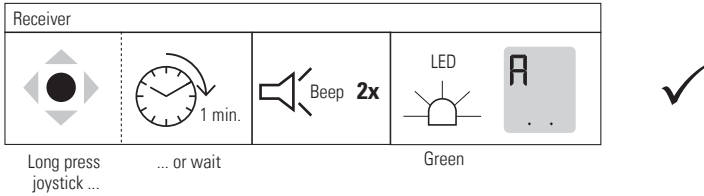

### Clear pairings

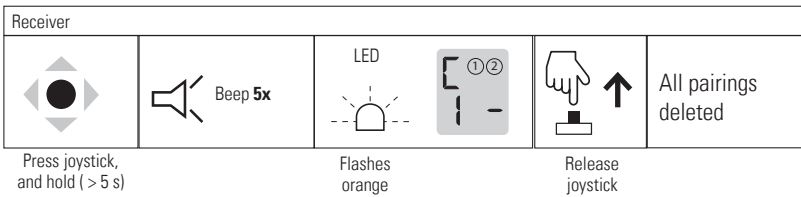

## 6 System test, mandatory after each set-up!

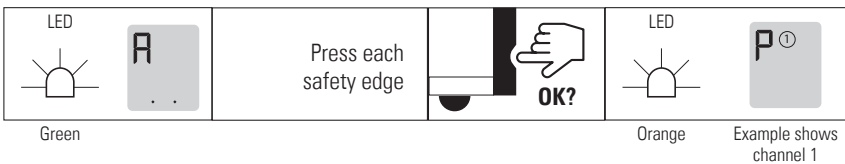

Does the door/gate stop when the sensing element is activated?

## 7 Receiver

### 7.1 Status LED, LCD, outputs

	LED SYS	Display	Output 1 14–11	Output 1 13–12	Output 2 24–21	Output 2 23–22	Output 3 5–6	Buzzer
No power supply	–	–	CLOSED	open	CLOSED	open	open	
Power-up	red		CLOSED	open	CLOSED	open	open	ends with 4x beep
System ready, no sensor pressed ) both dots flashing	green		8k2	closed	8k2	CLOSED	open	
Sensor 1 pressed (main closing edge)	orange		CLOSED	open	8k2	CLOSED	open	
Sensor 2 pressed (secondary closing edge)	orange		8k2	CLOSED	CLOSED	open	open	
Stationary sensor 1 pressed (output 1)	orange		CLOSED	open	8k2	CLOSED	open	
Stationary sensor 2 pressed (output 2)	orange		8k2	CLOSED	CLOSED	open	open	
Wicket door open (XRF-TW on channel 2)	orange		8k2	CLOSED	CLOSED	open	open	
Configuration a = Pairing; b = BSI, c = Stationary edges, d = Test Input	orange flashing		CLOSED	open	CLOSED	open	open	upon action
Configuration mode, memory full	orange flashing		CLOSED	open	CLOSED	open	open	10x
Low battery	green		8k2	CLOSED	8k2	CLOSED	CLOSED	3x every min.
Test input active ) 1 <sup>st</sup> dot stable, 2 <sup>nd</sup> dot flashing	green		CLOSED	open	CLOSED	open	open	
Error a = Broken cable between edge and input, resistor out of range b = Tx lost or empty battery c = System error	a = red b = red c = red		CLOSED	open	CLOSED	open	open	(see 8.2)

## 7.2 Menu structure

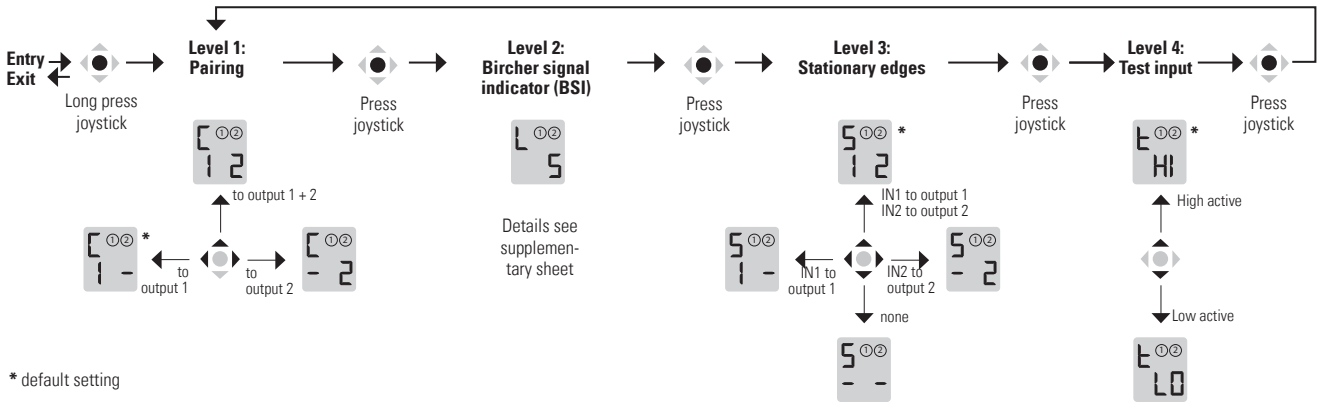

## 8 Trouble shooting

### 8.1 Warning indicator for low battery voltage

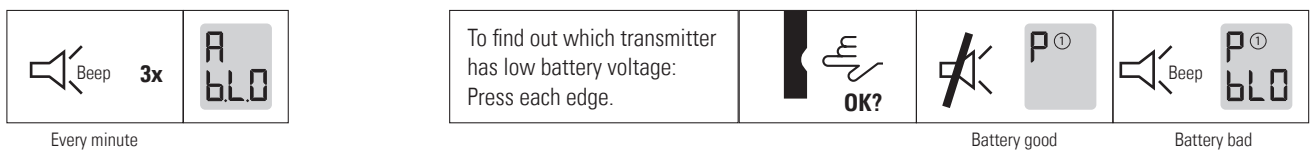

### 8.2 Errors (see 7.1)



## 9 Technical data

Receiver	
Supply voltage	12–36 V DC 12–36 V AC, 48–62 Hz
Power consumption	max. 1.0 W
Safety outputs (2 x 2 relays)	max. 36 V AC/DC; 1 A (NC with 1A fuse)
Output battery low (SSR)	max. 36 V AC/DC; 0.1 A
Input stat. sensors	Sensors with 8.2 kOhm resistor
Test input	max. 36 V DC; 36 V AC, 48–62 Hz max. 11 mA U <sub>th</sub> > 10 V AC/DC
Antenna connection (optional)	SMA (f)
Number of supported sensors	max. 14 (stationary sensors included)
Mounting	DIN-rail
Protection class IEC 60529	IP20

System	
Operating frequency	868.3 MHz
Reaction time	Typ. 15 ms
Range	60 m (at optimal condition)
According to EN ISO 13849-1	PLd for Cat. 3 applications + test input for Cat. 2 applications
Operating temperature	–20 °C to +60 °C

## 10 EU Declaration of Conformity

CE See attachment

## 11 WEEE



Devices with this symbol must be treated separately during disposal. This must be done in accordance with the laws of the respective countries for environmentally sound disposal, processing and recycling of electrical and electronic equipment.

## 12 Contact

**BBC Bircher Smart Access**, BBC Bircher AG, Wiesengasse 20, CH-8222 Beringen, [www.bircher.com](http://www.bircher.com)

Designed in Switzerland / Made in China