

Helios 2T

Microwave motion and AIR presence detectors for industrial doors

Translation of the original instructions

General

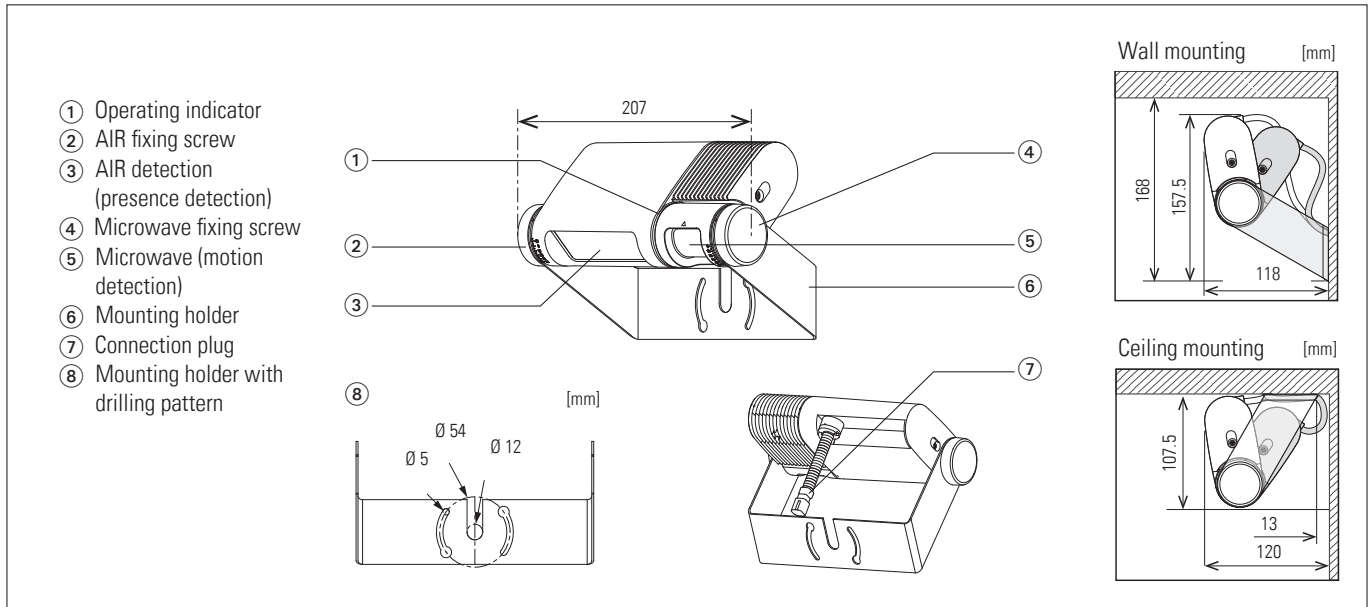

1 Safety instructions

The device may only be installed and operated by trained and qualified personnel.

Before starting work, make sure that the power supply is switched off.



The device may only be opened and repaired by the manufacturer.

The device may only be connected to a protection low-voltage system with safe electrical separation.

Always consider the safety functions of your application as a whole, never just in relation to one individual section of the system.

The installer is responsible for carrying out a risk assessment and installing the detector and the system correctly.

Avoid touching any electronic components.

1.1 Manufacturer declarations

- This product is a contact-free detector intended for mounting on a wall or ceiling and used with an industrial door.
- When adjusting the settings for the detection zone, make sure that there are no moving objects inside the zone.
- Before switching on the power supply, check the wiring as a precaution to prevent any damage or malfunction affecting the equipment connected to the product.
- Only use the product as described in this operating instructions.
- Make sure to install and adjust the detector in line with the laws and standards that apply in the country where the product is being installed.
- If you are leaving the installation site, make sure that the product is working properly and has been installed correctly. Explain to the building owner/operator the correct way of operating the industrial door and the product.
- Only an installer or a service technician may change the product settings. If changes are required, the settings that are made and the date on which they are made must be recorded in the industrial door maintenance manual.



Warning: Failure to observe the applicable instructions and handling the equipment incorrectly can result in serious or fatal injuries.



Caution: Failure to observe the applicable instructions and handling the equipment incorrectly can result in personal injury and/or damage to property.



Note: Pay particular attention to sections with this symbol.

The following conditions are unsuitable for detector installation:

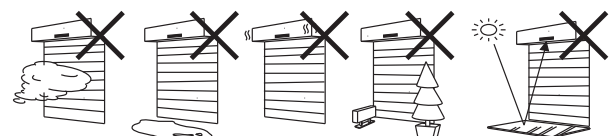

Fog, smoke

Moisture

Vibrations

Objects

Reflections

2 Scope of delivery and mounting

2.1 Scope of delivery

- Detector
- 10 m connection cable with plug connector
- Mounting holder
- 2 mounting screws
- Operating instructions

2.2 Mounting

1. Loosen the two fixing screws to remove the detector housing from the mounting holder. Take care not to lose any of the parts.
2. Working in the middle area above the industrial door, drill two mounting holes of \varnothing 3.4 mm that match up with the drilling pattern for the mounting holder.
3. If necessary, drill a hole of \varnothing 10 mm for feeding the connection cable through the wall or ceiling.
4. Fix the holder in place using the mounting screws supplied. Then reattach the detector housing to the mounting holder and screw the fixing screws in tightly.

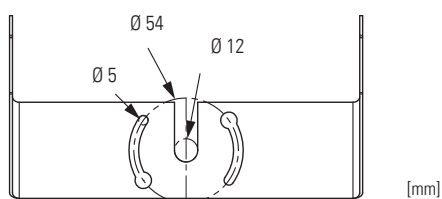

Mounting examples

Wall mounting

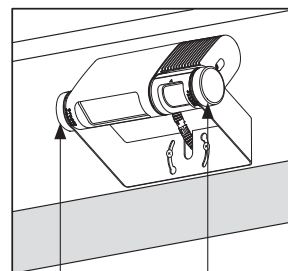

Ceiling mounting

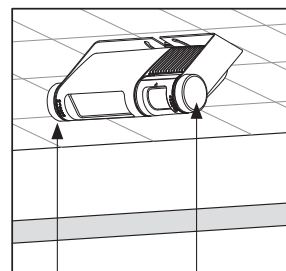

- ① AIR fixing screw
- ② Microwave fixing screw

3 Electrical connections



Warning! Before starting work, make sure that the power supply is switched off. Take care not to damage the connection cable while feeding it through the hole in the wall or ceiling.

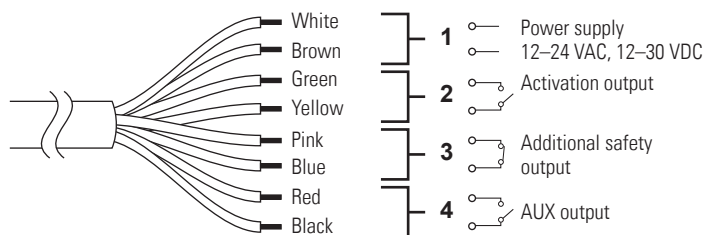

1. Wire the connection cable to the industrial door control system as shown on the left.
2. Connect the detector plug connector to the connection cable connector.
3. Switch on the power supply. Adjust the detector zones (see chapter 4.3) and the settings using the mobile app (see chapter 4.1).

Note: Make sure that the connection cable is correctly connected to the industrial door control system before switching on the power supply. After switching on the power supply and after adjusting the settings using the app, avoid stepping or driving into the detection zone for 10 seconds.

4 Configuration

4.1 Mobile app for detector configuration

Use a smartphone or tablet to change the Helios 2T settings. The app is free, but downloading it may incur some connection charges.

Before using the app

By using the mobile app, you consent to the specified licensing and data privacy policies, and to the use of smartphone/tablet location information and the Bluetooth* function.

Both functions (location identification and Bluetooth*) must be activated in order to use the mobile app.

? You can select this icon in the mobile app to obtain additional useful information.

i Note: To retrieve and enter the location address, simply activate the location information function on the smartphone or tablet.



Google Play and the Google Play logo are trademarks of Google LLC. App Store is a service mark of Apple Inc.

Logging in on the detector

Default password: 0000

When you open the app for the first time, the user settings screen will appear. Entering the information is optional. The user information can be edited at any time. When you close the settings, the device list will show you all the detectors available via Bluetooth*.



Caution – security risk: We recommend changing the password. Otherwise, unauthorised persons could change the settings and affect the detector functions.

* The Bluetooth® word mark and logos are registered trademarks owned by Bluetooth SIG, Inc. and any use of such marks by BBC Bircher AG is under license.

4.2 Adjusting the detector angle

The detector has a scale on its left and right-hand sides, and there are markings for wall or ceiling mounting on the mounting holder.

Note: Before adjusting the detector angle, loosen the corresponding fixing screw to prevent any damage to the detector housing (see chapter 2.2).

1. Loosen the AIR/microwave fixing screw
2. Adjust the AIR/microwave angle
3. Tighten the AIR/microwave fixing screw

The AIR and microwave angles can be adjusted independently of one another.

AIR fixing screw (left)

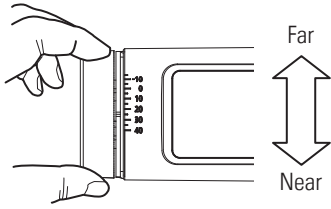

Microwave fixing screw (right)

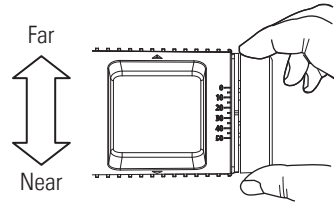

Markings on the mounting holder

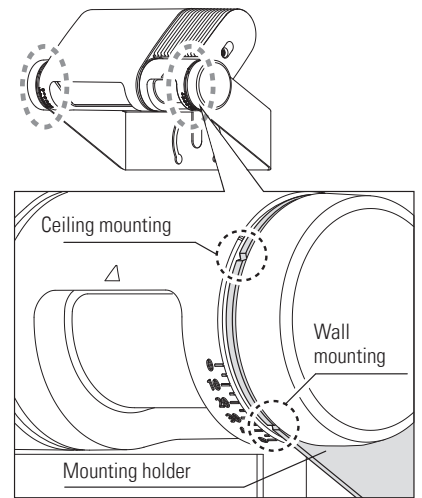

The detector has two AIR rows that are mechanically linked to one another. This means they have a shared detection zone for adjustment (see image in chapter 4.3).

To adjust the AIR rows, close the industrial door and activate installation mode in the app ("ON"). This will prevent the industrial door from moving during work on the detector. Once you have finished making the settings, switch off installation mode again ("OFF").

4.3 Detector zones (reference)

AIR (presence detection)

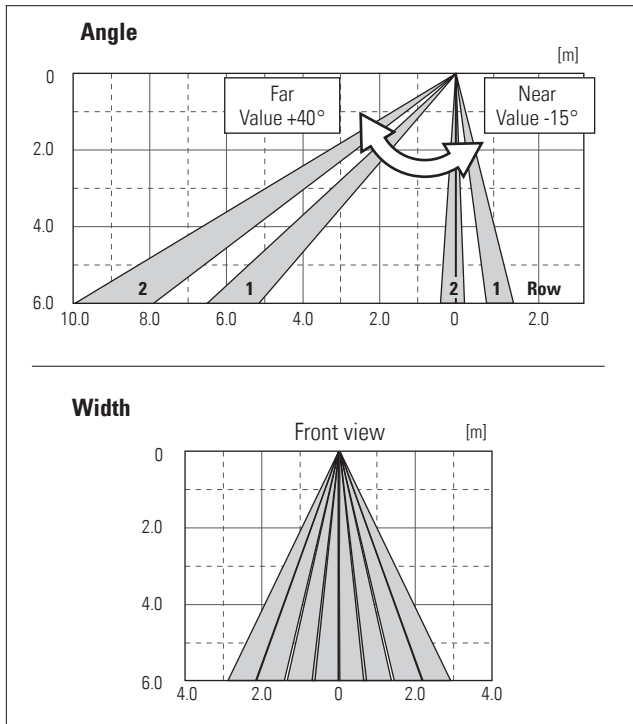



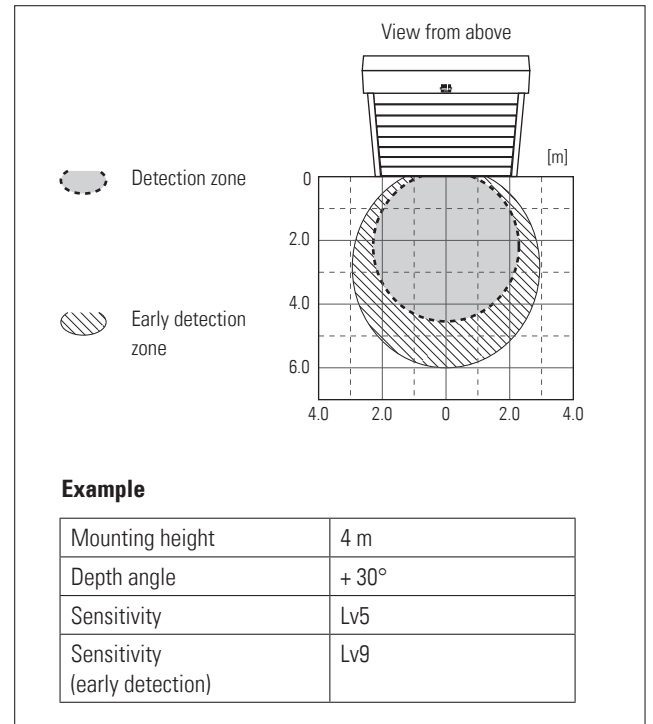

Microwave (motion detection)



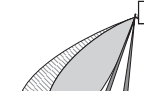
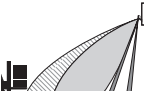

Note: Make sure that the AIR detection zone does not detect the industrial door leaf and that there are no highly reflective objects near it. Otherwise, false tripping or signal saturation may occur.

4.4 Checking

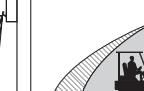
Check operation by stepping or driving into the detector zones. The images below are only examples.

Status/ Position	Power supply OFF	Teach-in phase (approx. 10 s)	Outside detection zone	Stepping into microwave zone (early detection)	Stepping into microwave zone	Stepping into second AIR row	Stepping into first AIR row
							
Operating indicator	Off	Flickers green	Green	Flashes orange	Orange	Red	Flashes red

	Microwave zone (early detection) (motion detection)
	Microwave zone (motion detection)
	AIR zone (presence detection)

Other operating displays

Status	Operating indicator
Readiness (installation mode)	Yellow
Signal saturation	Flashes green slowly
Equipment fault	Flashes green quickly
Detector connecting to app	Flashes green and blue slowly

5 Technical data

Model	Helios 2T
Colour	Black
Mounting height	2.0 m to 6.0 m ¹
Transmission frequency	24.2 GHz
Radiated detector power	< 12.7 dBm
Detection zone	See information on detection zone
Detection method	Microwave Active infrared ²
Angle adjustment	Microwave zone: 0 to +50° AIR zone –15 to +40°
Power supply	12 to 24 VAC ±10% (50/60 Hz) 12 to 30 VDC ±10%
Power consumption	3 W (< 4.5 VA with AC)
Operating indicator	See information on checking (chapter 4.4)
Output fall-delay time	> 0.5 s (can be selected via app)
Response time	< 0.3 s (can be selected via app)

Operating temperature	–35 to +55°C
Air humidity	< 80% rel.
Communication method	Bluetooth LE (version 4.0)
Activation output	Semiconductor relay, max. 50 VAC/VDC Max. 0.3 A (resistance load)
Additional safety output	Semiconductor relay, max. 50 VAC/VDC Max. 0.3 A (resistance load)
AUX output ³	Semiconductor relay, max. 50 VAC/VDC Max. 0.3 A (resistance load)
Protection class	IP65/NEMA4
Weight	600 g

Note: We reserve the right to change the technical data in this document without notice if improvements are made to the equipment.

¹ A person can be detected at an installation height of up to 4 m.

² Active infrared has a presence detection function.

³ Additional output for warning light, etc.

6 Declaration of conformity

 See attachment

7 WEEE



Devices with this symbol must be treated separately during disposal. This must be done in accordance with the laws of the respective countries for environmentally sound disposal, processing and recycling of electrical and electronic equipment.

8 FCC approval



This device meets the requirements of Part 15 of the FCC regulations and the RSS-210 standard of Industry Canada.

Warning: Changes or modifications made to this device may void the FCC authorisation to operate this device.

9 Contact

BBC Bircher Smart Access, BBC Bircher AG, Wiesengasse 20, CH-8222 Beringen, www.bircher.com

Designed in Japan / Made in China